











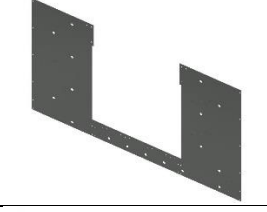



Owners Installation Manual

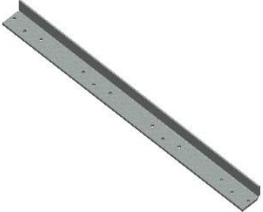
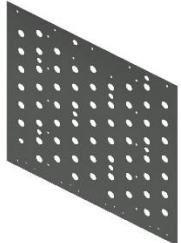
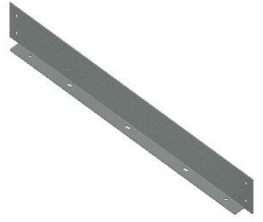
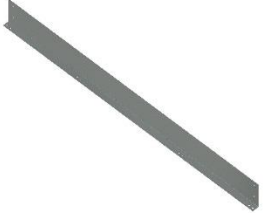
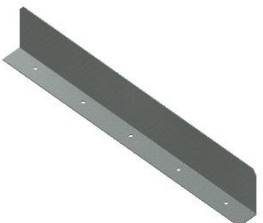
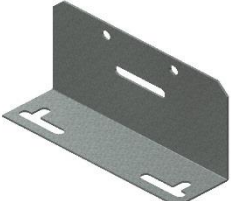



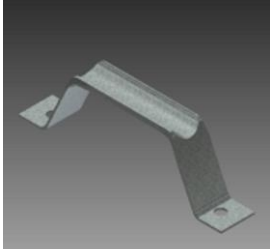

36" 18X8 Double Head Rest Platform

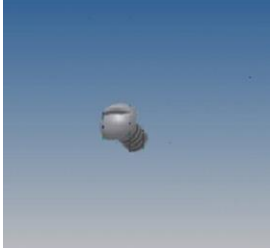
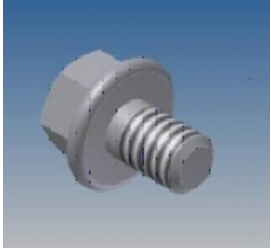
PARTS LIST

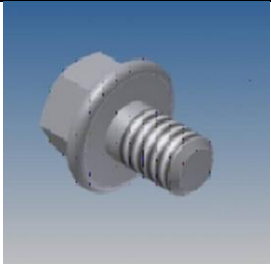
	Preview	ITEM	PART NUMBER
1		PRIMARY SUPPORT CHANNEL 68 3/4" X 7 3/4" -10 GA 3PS REQ'D	BE-00869
2		SECONDARY SUPPORT CHANNEL 89" X 7 7/16" - 10 GA 2 PCS REQ'D	BE-00868
3		DOOR SIDE PANEL 68 1/4" X 41" -14 GA 1 PCS REQ'D	BE-00870
4		KICK BRACES 1 56 9/16" X 3" - 10 GA 1 PCS REQ'D	UREST36.006
5		KICK BRACES 2 56 9/16" X 3" - 10 GA 1 PCS REQ'D	UREST36.006-MIR
6		DOOR SUPPORT ANGLE 41 3/8" X 3 1/2" - 10 GA 2 PCS REQ'D	UWORKP36.011
7		DOOR STIFFENER 23" X 3" - 10 GA 2 PCS REQ'D	UREST36.010

8		<p>HINGE STIFFENER 25 5/8" X 2 1/2" - 10 GA 2 PCS REQ'D</p>	UREST36.009
9		<p>FLOOR PANEL DOOR 28 1/2" X 26 3/4" - 14 GA 1 PCS REQ'D</p>	USERVP36.M04A
10		<p>SIDE TOE BOARD 41 1/4" X 5 1/2" - 10 GA 2 PCS REQ'D</p>	UREST36.002
11		<p>FRONT/REAR TOE BOARD 68 1/2" X 5 1/2" - 10 GA 2 PCS REQ'D</p>	BE-00871
12		<p>TOE BOARDS FOR DOOR AREA 31" X 6 1/4" - 14 GA 1 PCS REQ'D</p>	UREST36.008
13		<p>SHORT DOOR TOE BOARDS 7 3/4" X 6 1/4" - 14 GA 2 PCS REQ'D</p>	UREST36.008-1
14		<p>SIDE HANDRAIL 40 1/2" - FLATTENED 14 GA 4 PCS REQ'D</p>	UREST36.004

15		<p>FRONT AND BACK HANDRAIL 68" – FLATTENED 14 GA 4 PCS REQ'D</p>	BE-00874
16		<p>RAIL POSTS 42" X 4" – 10 GA 4 PCS REQ'D</p>	USERV16.018
18		<p>DOOR HANDLE PURCHASED 1 PC REQ'D</p>	GLA-HANDLE
17		<p>GLA-HINGE PURCHASED 4 PC REQ'D</p>	GLA-HINGE
19		<p>SLOTTED TRUST BOLT – 5/16"</p>	HDBST005012JCB
20		<p>FLANGE HEX BOLT – 5/16"</p>	HDBF005012JCB

21		FLANGE HEX BOLT – 3/8" X 3/4"	HDBF006012JCB
22		FLANGE HEX BOLT – 3/8" X 1"	HDBF006100JCB
23		SERATED FLANGE HEX NUT – 5/16"	HDNFS005JCD
24		SERATED FLANGE HEX NUT – 3/8"	HDNFS006JCD
25		FLANGE HEX BOLT – 1/4"	HDBH004012ZCD
26		FLANGE HEX NUT – 1/4"	HDNH004ZCD

STEP:

1. Start by standing a 10' piece of trunk up on its side.
2. Now bolt the Primary Support Channels (**#1**) on both sides of the elevator trunking at the desired height of the rest platform. Also bolt the third Primary Support Channel (**#1**) in the fourth set of holes down from the original support channels on the ladder side, as shown in the diagram. Use the 3/8" X 1" bolts (**#22**) for the support channels.

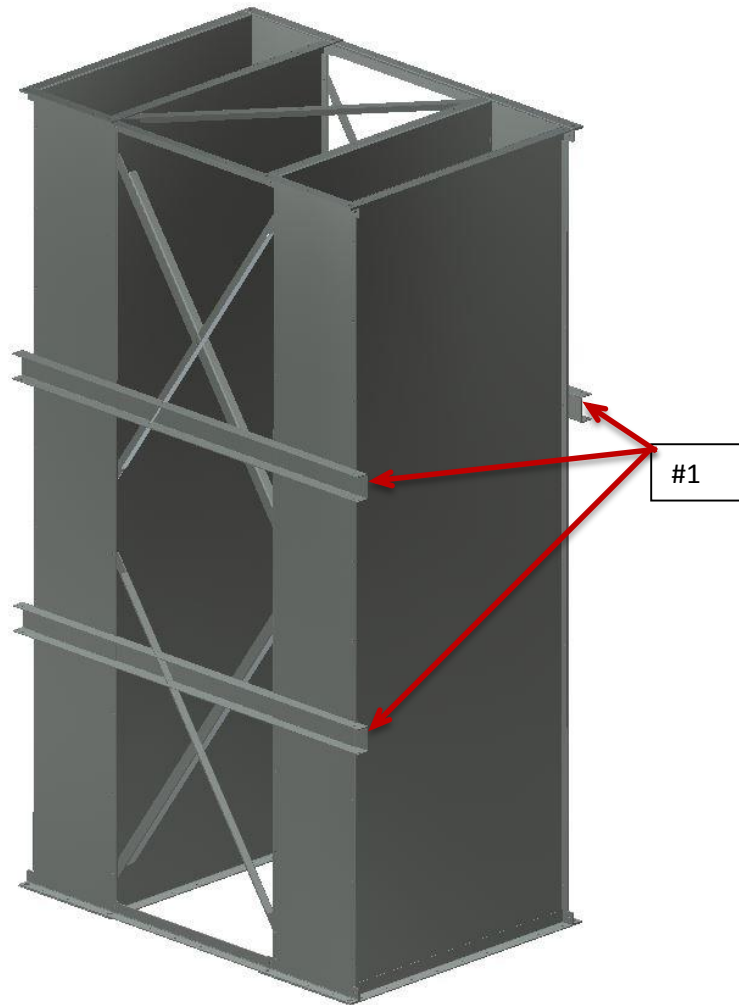

3. Now bolt the (2) Secondary Support Channels (**#2**) to the top of the primary support channels using the 3/8" bolts. The (2) Kick Braces (**#4, #5**) can also be mounted at this stage. They mount from the third bolt in on the Secondary Support Channel to the upper lip of the Primary Support Channel. **Note:** the kick brace ends require approximately a 45° bend to properly fit.

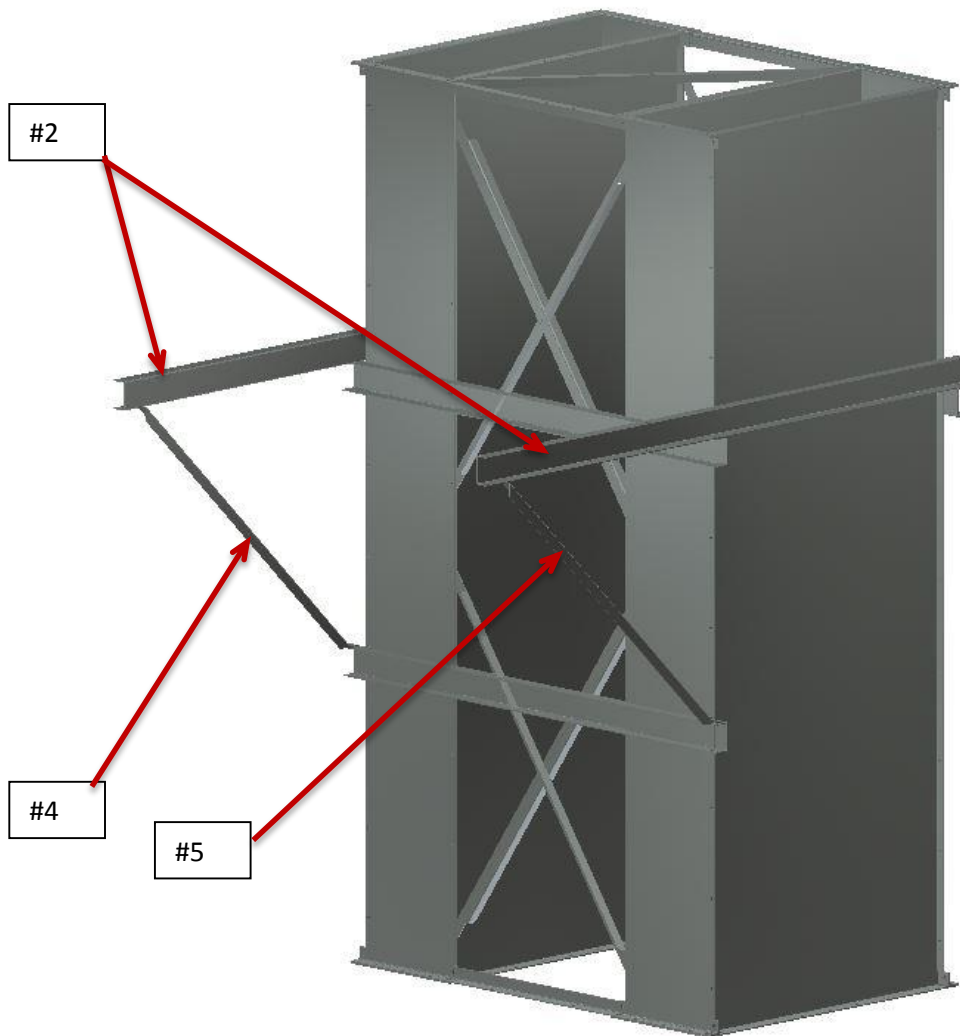

4. Now locate the Door Panel (#9), and Floor Panel (#3). The Door Panel will require 4 hinges (#18), Long Door Toe Board (#12), and Handle (#17) mounted to the top. The hinges are to be fastened using 1/4" x 1" bolts, with the hinge stiffeners (#8) bolted to the underside of the assembly (see Bottom View). The floor panel will require Front/Rear Toe Boards (#11) to be fastened **beneath** the floor panel to provide the necessary support. The (2) Short Door Toe Boards (#13) will fasten to the top of the floor panel.

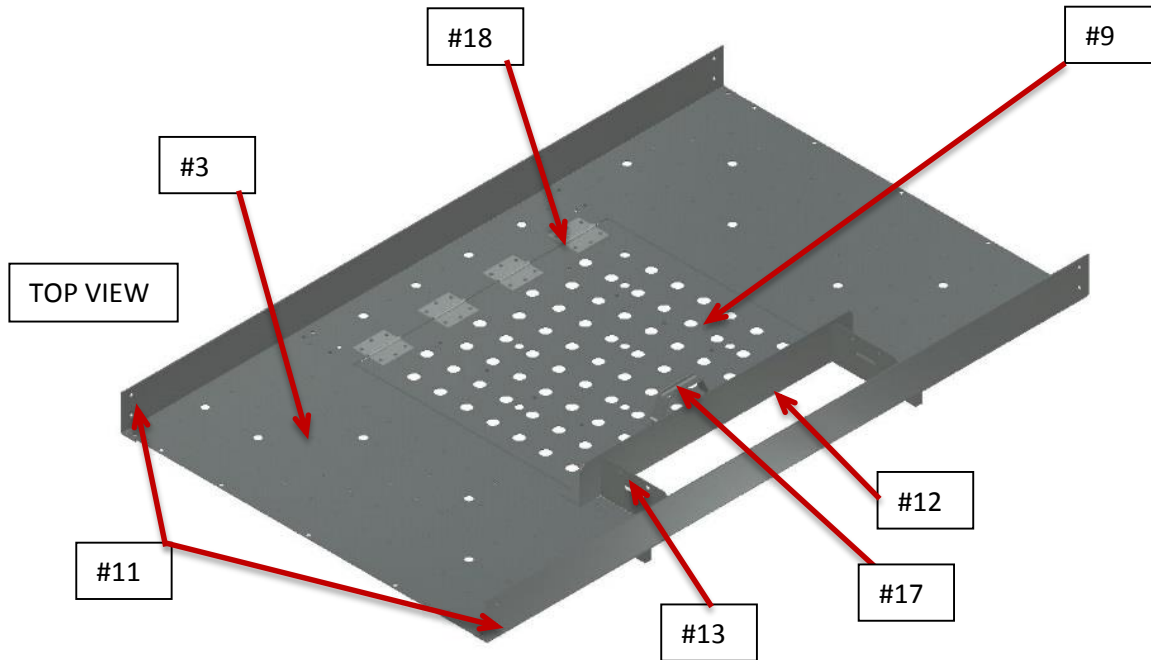

On the underside of the Door/Floor panel assembly, (2) Door Support Angles (#6), (2) Door Stiffeners (#7), and (2) Hinge Stiffeners (#8) will be fastened.

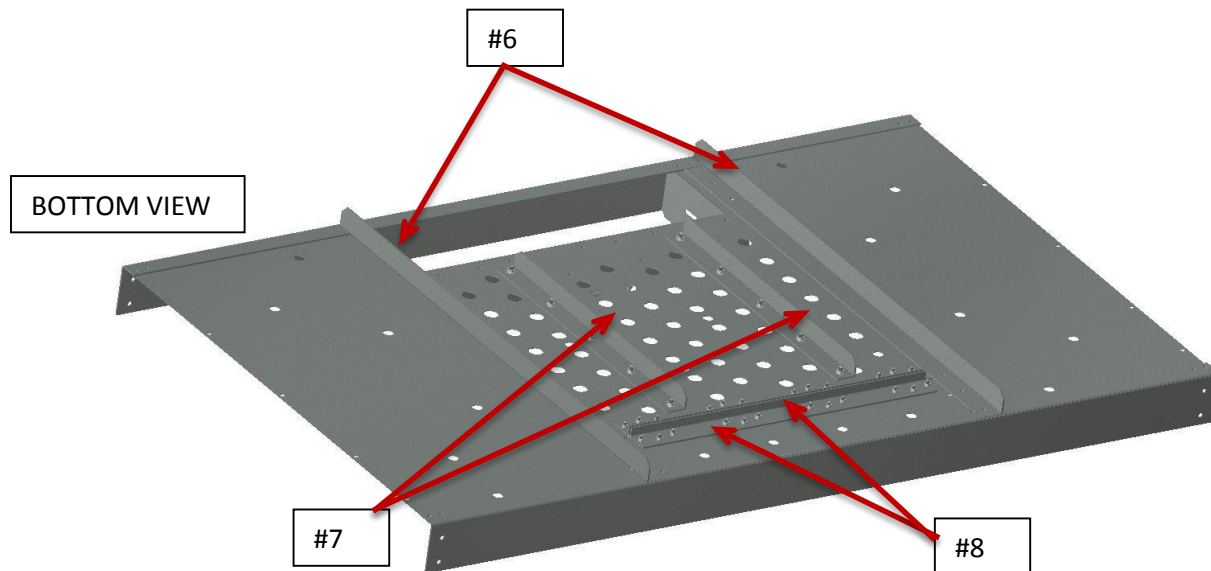

5. Now place the Floor Section on the secondary supports and bolt all four corners securely using the 5/16" truss bolts. The (2) Side Toe Boards (#10) can also be installed at this stage beneath the floor section on the secondary supports as shown. All floor bolts can now be installed (5/16" truss bolts).

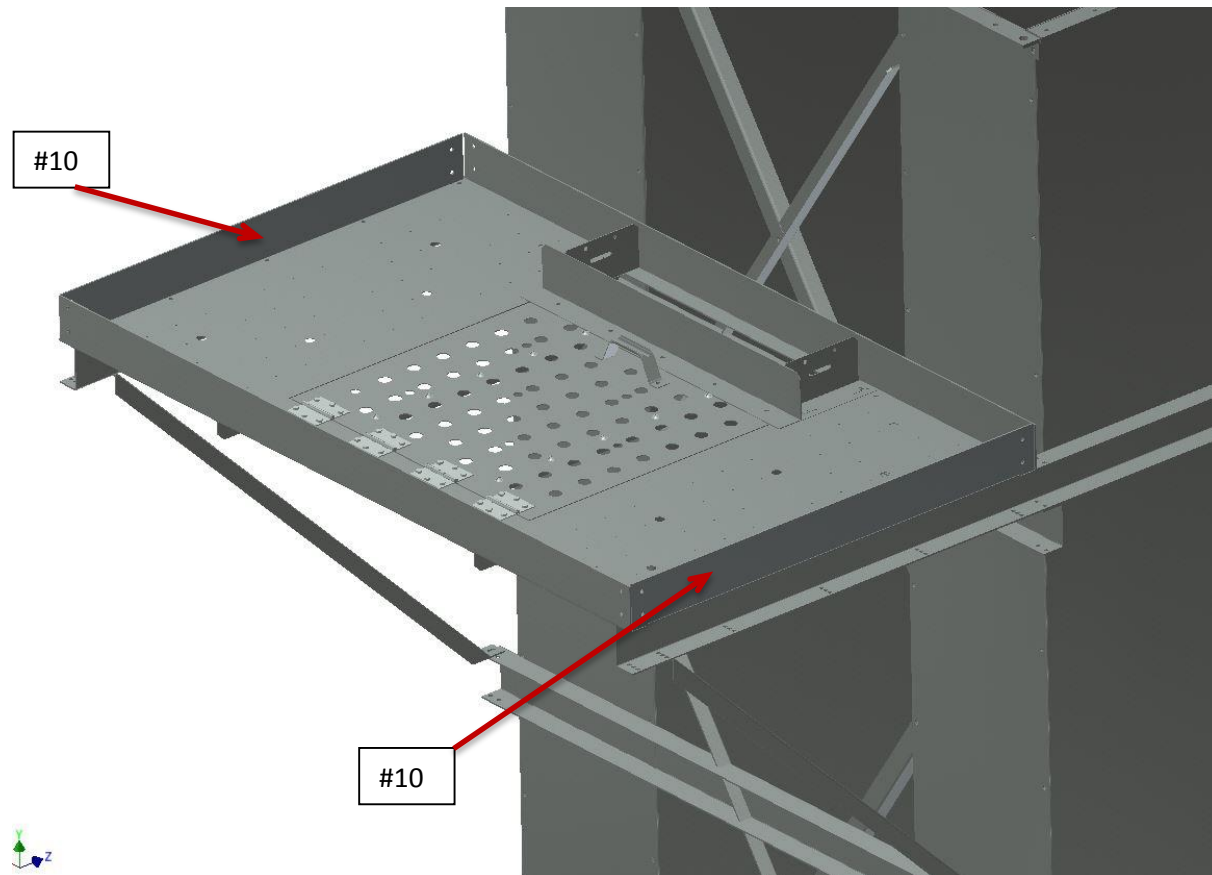

6. With the Door Panel & Toe Boards in place the ladder will need to be drilled and bolted to the short door toe boards on each side using (2) 5/16" x 3/4" bolts.

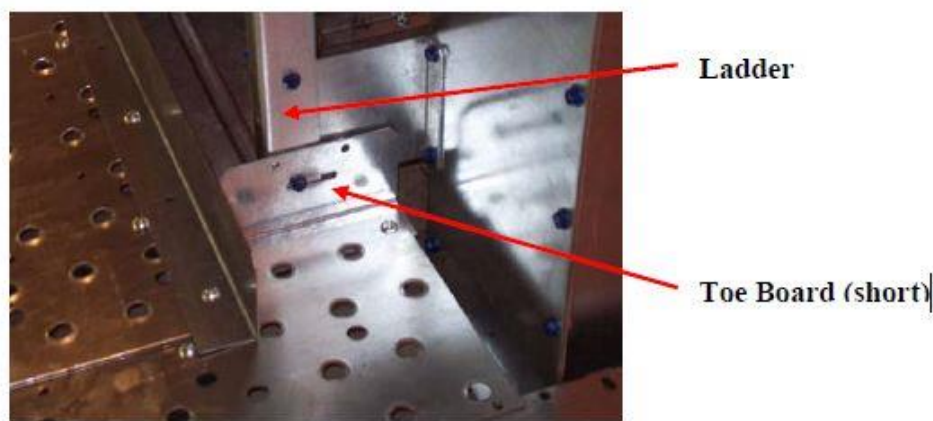

7. Install 4 Rail Posts (#16) at the 4 corners of the platform, attach the (4) Short Handrails (#14) to the Posts then attach the (4) Long Handrails (#15) to the Posts.

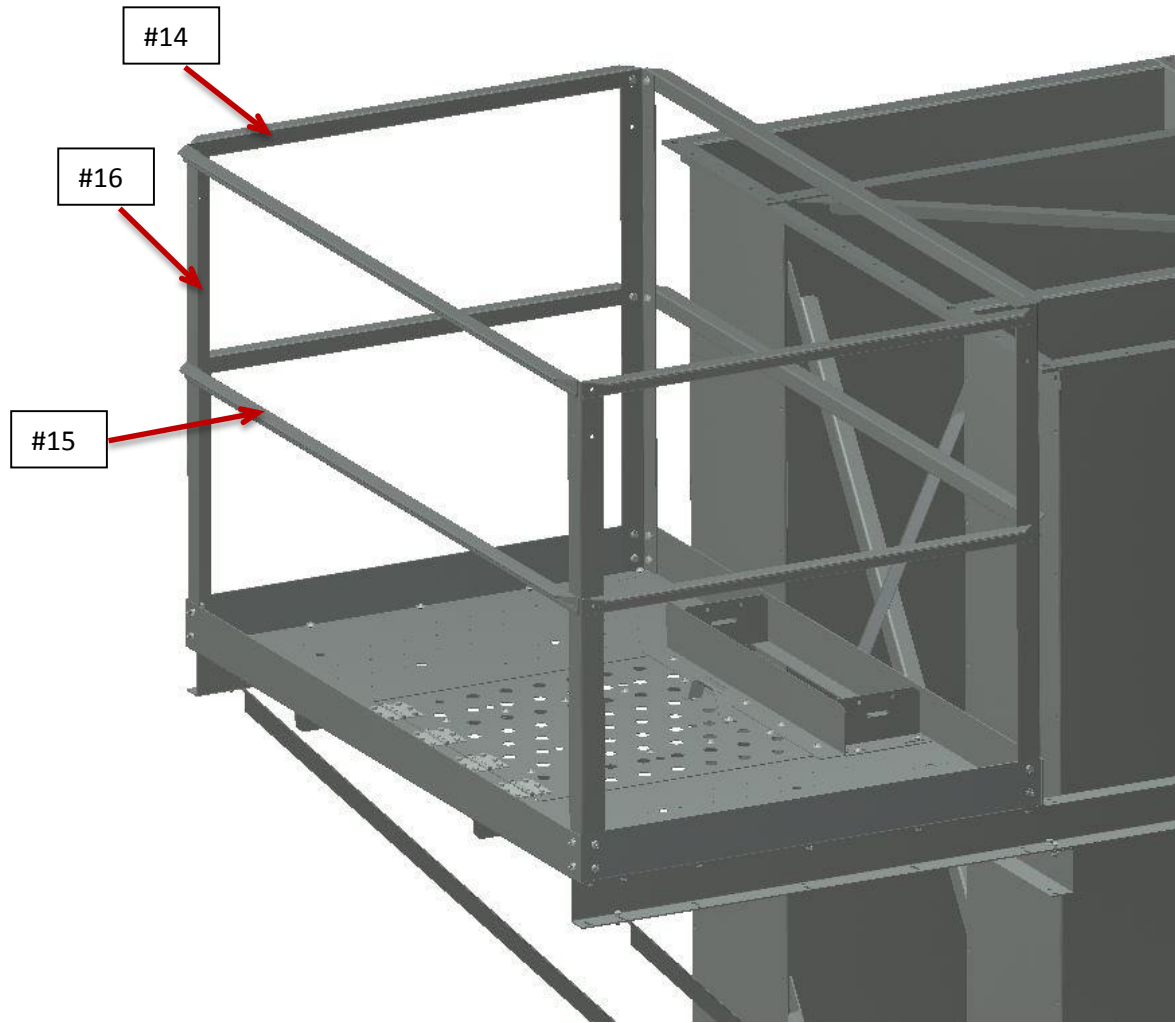

Completed – 36” Double 18X8 Rest Platform

